

SLIM LINEAR INGROUND LIGHT

Designed to create fantastic possibilities;
Enhance architecture with superior visual comfort;
Can be used indoors and outdoors, in walls or floors;
Allowing designers and architects' desire for any project.



FEATURES

- 12mm tempered frosted glass
- Seamless connection installation
- Extremely ultra-thin anti-rust stainless steel frame
- Uniform and milky illumination providing visual enjoyment
- Integrated into the surroundings and compatible with the architecture

STANDARDS

.IEC/EN60598-1.IEC/EN60598-2-2

.IEC/EN61000-3-2.IEC/EN61000-3-3

.IEC/EN61547.EN55015

.IEC/EN62031.ROHS

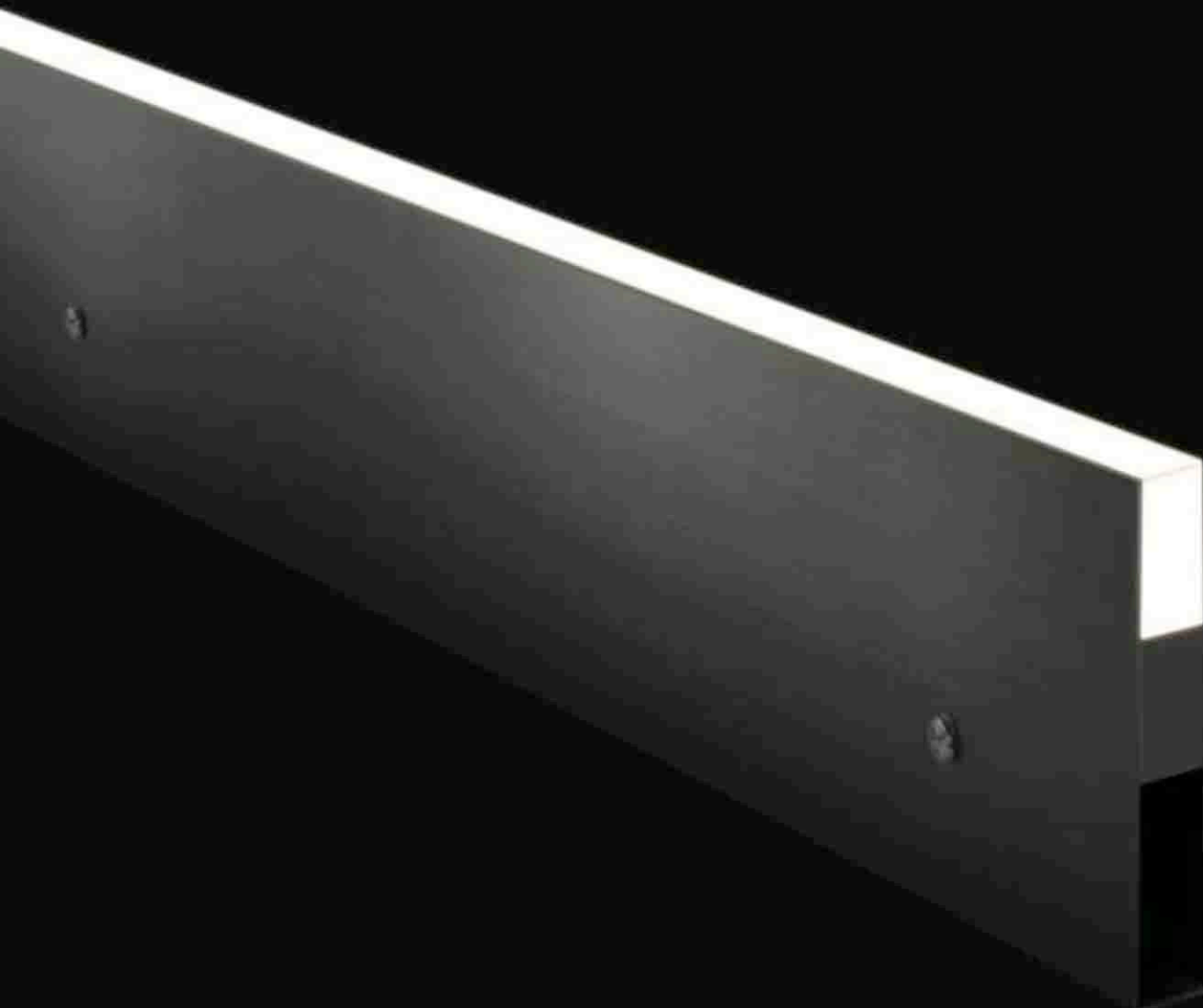

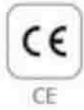

CE



RoHS



SMD 48pcs LED



IP67



IK10



Equipped with a stainless steel recessing box, ensuring full corrosion resistance.

Drawings(mm)

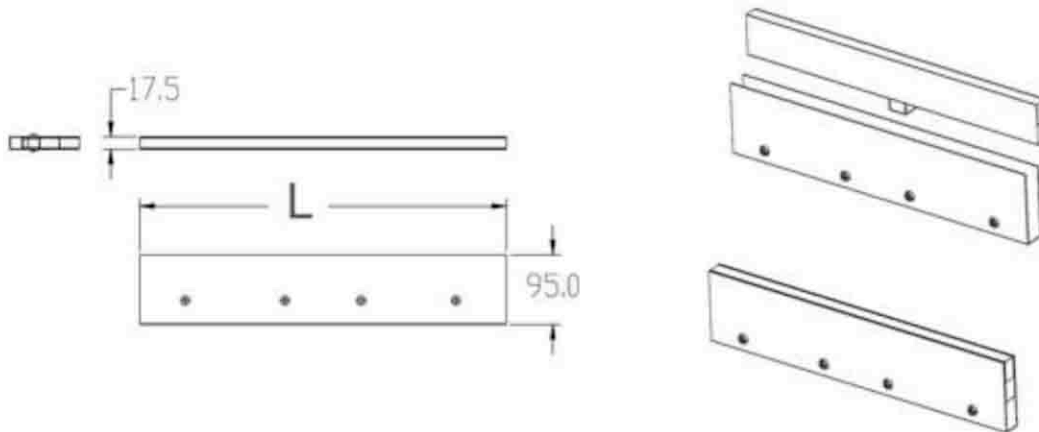

Application

Suitable for city square, commercial hotel, landscape night view design. Attracting visitors to stay to enjoy the beautiful night view.

MODEL NO.
FL-SLG-12M-12W

Luminaire

Product type: LED Linear Tile Light
 Material: Stainless steel + Tempered Glass
 Section Dimension: W15XH55mm
 IP Rating: IP67
 IK Rating: IK10
 Warranty: 3 Years

Light Source

Light source: SMD
 Lumen output: 50lm/W
 CRI: Ra>80
 CCT: 3000K/4000K/5000K/6000K
 Light emission: 120°
 Life-span: 50000Hrs

Electrical Equipment

Input voltage: DC12/24V
 Operating Temperature: -15~60℃

Accessories

Product type: Embedded box
 Material: Stainless steel
 Section Dimension: W17XH95mm



Drawings(mm)

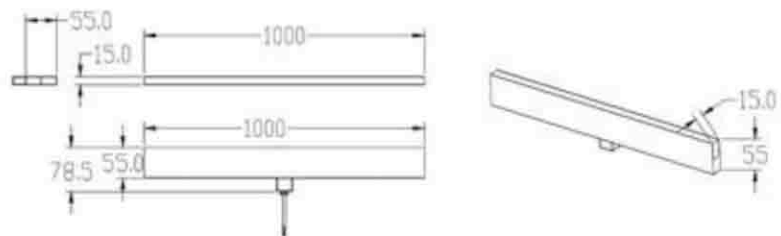

Part No.	Dimension(mm)	Power	Voltage	Color	LED QTY
FL-SLG-12M-12W-12	L1000*W17*H95	12W	DC12V	WW/NW/CW	120 LEDs
FL-SLG-12M-12RGB-12	L1000*W17*H95	12W	DC12V	RGB	120 LEDs
FL-SLG-12M-12W-24	L1000*W17*H95	12W	DC24V	WW/NW/CW	120 LEDs
FL-SLG-12M-12RGB-24	L1000*W17*H95	12W	DC24V	RGB	120 LEDs





MODEL NO.
FL-SLG-12M-6W

Luminaire

Product type: LED Linear Tile Light
 Material: Stainless steel + Tempered Glass
 Section Dimension: W15XH55mm
 IP Rating: IP67
 IK Rating: IK10
 Warranty: 3 Years

Drawings(mm)

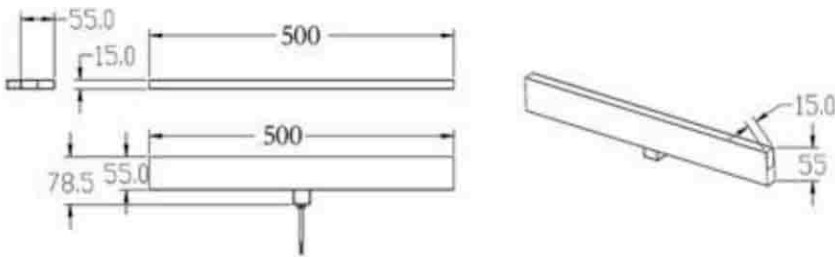

Light Source

Light source: SMD
 Lumen output: 50lm/W
 CRI: Ra>80
 CCT: 3000K/4000K/5000K/6000K
 Light emission: 120°
 Life-span: 50000Hrs

Part No.	Dimension(mm)	Power	Voltage	Color	LED QTY
FL-SLG-12M-6W-12	L500*W17*H95	6W	DC12V	WW/NW/CW	60 LEDs
FL-SLG-12M-6RGB-12	L500*W17*H95	6W	DC12V	RGB	60 LEDs
FL-SLG-12M-6W-24	L500*W17*H95	6W	DC24V	WW/NW/CW	60 LEDs
FL-SLG-12M-6RGB-24	L500*W17*H95	6W	DC24V	RGB	60 LEDs

Electrical Equipment

Input voltage: DC12/24V
 Operating Temperature: -15~60℃

Accessories

Product type: Embedded box
 Material: Stainless steel
 Section Dimension: W17XH95mm





LED TILE LIGHT SERIES

LED Tile Light is designed for landscape project. It is easy to install or embedded in stone, concrete and pavers. Widely used on squares, patios, walkways or plazas illumination.

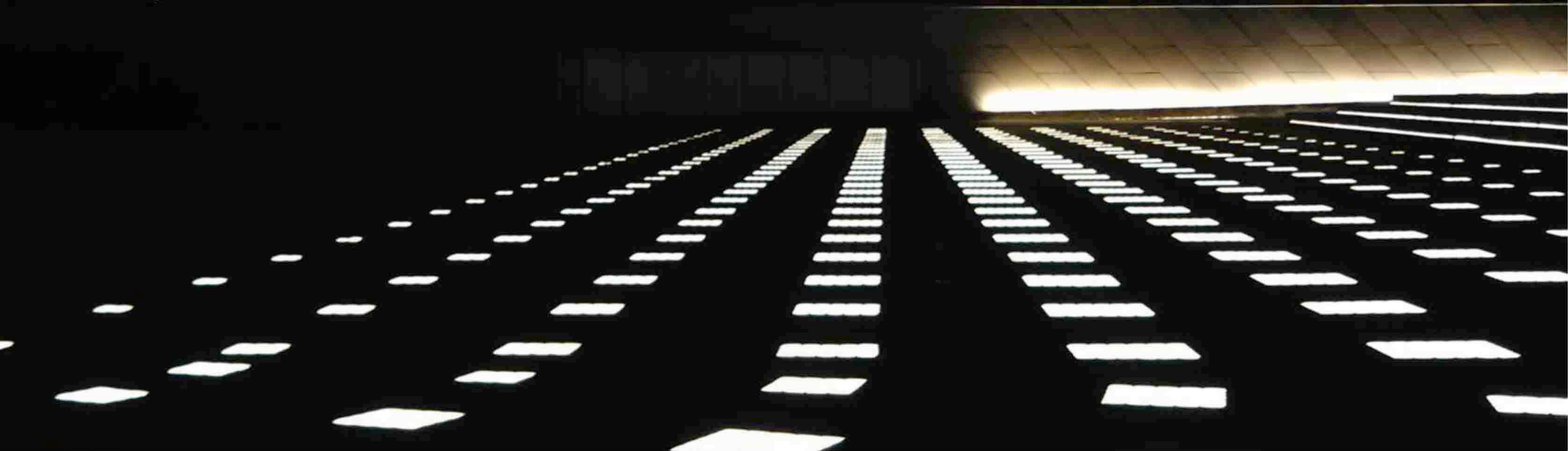

Features:

- Anti-slippery frosted glass.
- Walk-over/driver-over tempered glass.
- Anti-rust and anti-corrosion stainless steel fixtures
- Good quality SMD LED chips with more than 5 years lifespan.
- Variety of colors for option.
- Perfect waterproofing for outdoor and indoor project.
- Size and shape custom-made available.
- Light what you think and what you like.

STANDARDS

.IEC/EN60598-1.IEC/EN60598-2-2

.IEC/EN61000-3-2.IEC/EN61000-3-3

.IEC/EN61547.EN55015

.IEC/EN62031.ROHS



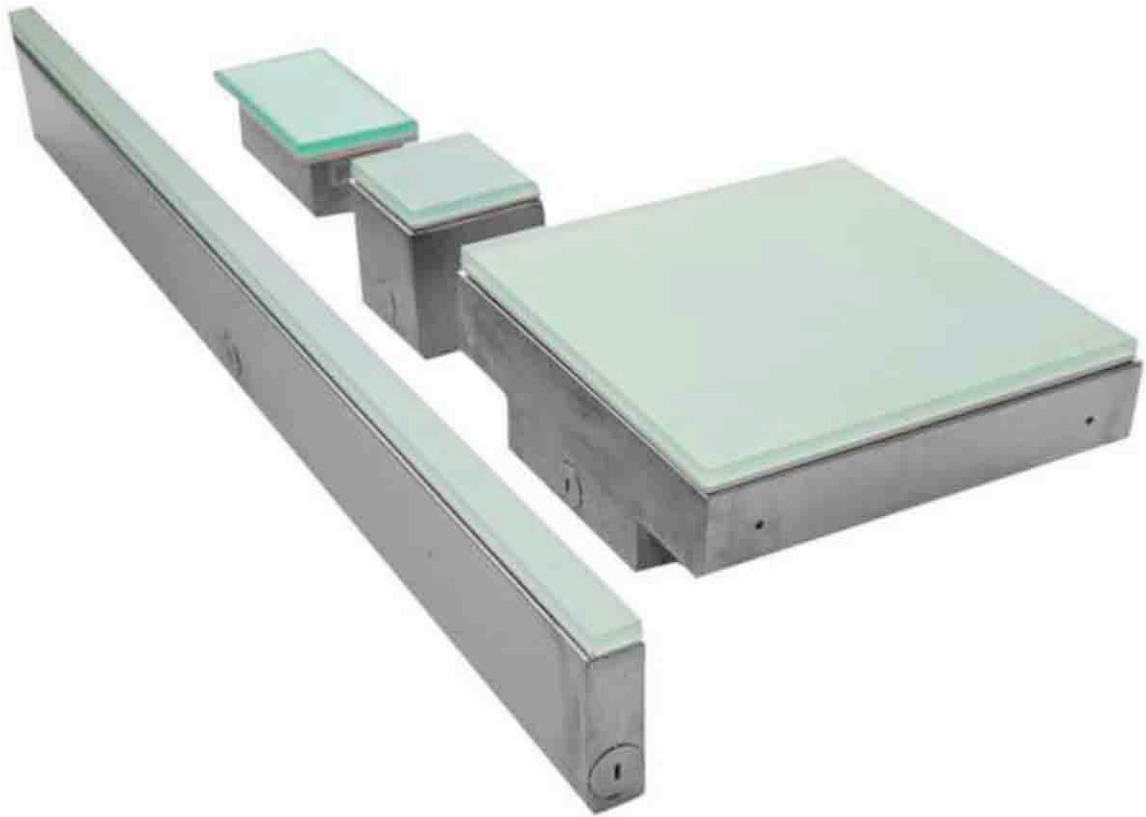

Installation Guidance

Sealed by Neutral Silicone Sealant

Concrete

Installation Box

Sand layer

Gravel layer

Soil layer

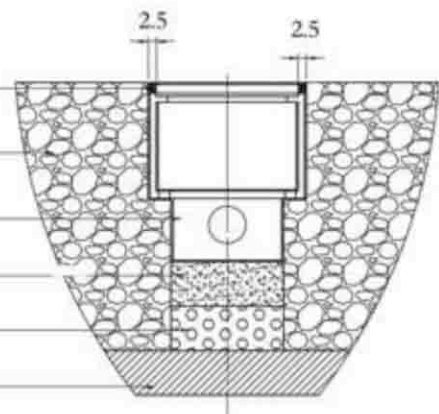

Application

Suitable for city square, commercial hotel, lanfscap night view design.

CUSTOM SIZE AVAILABLE

MODEL NO.
FL-LTS100X100

Luminaire

Product type: LED Tile Light
 Material: Stainless steel + Tempered Glass
 Dimension: H100 * W100 * H70mm
 IP Rating: IP67
 IK Rating: IK10
 Warranty: 3 Years

Light Source

Light source: SMD
 Lumen output: 30lm/W
 CRI: Ra>80
 CCT: 3000K/4000K/5000K/6000K
 Light emission: 120°
 Life-span: 50000Hrs

Electrical Equipment

Input voltage: DC12/24V
 Operating Temperature: -20~65°C

Accessories

Product type: Embedded box
 Material: Stainless steel
 Dimension: 105*105*100mm



Drawings(mm)

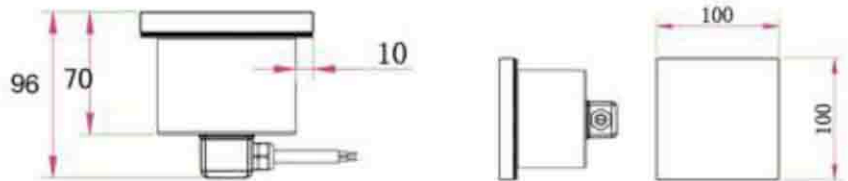

Part No.	Dimension(mm)	Power	Voltage	Color
FL-LTS100X100WD1	L100*W100*H70	1.3W	DC12V	WW/NW/CW
FL-LTS100X100SD1	L100*W100*H70	1.3W	DC12V	R/G/B/Y
FL-LTS100X100RGBD1	L100*W100*H70	1.3W	DC12V	RGB
FL-LTS100X100WD2	L100*W100*H70	1.3W	DC24V	WW/NW/CW
FL-LTS100X100SD2	L100*W100*H70	1.3W	DC24V	R/G/B/Y
FL-LTS100X100RGBD2	L100*W100*H70	1.3W	DC24V	RGB

NOTE: WW-Warm white, NW-Natural white, CW-cold white, R-red,G-green,B-Blue, Y-Yellow

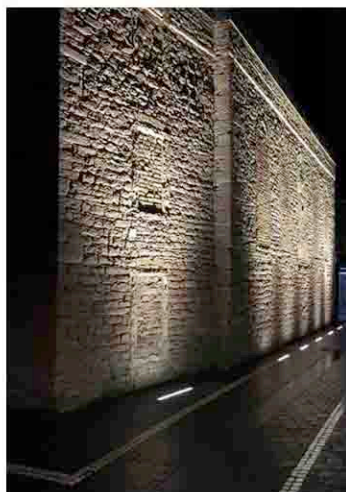



MODEL NO.
FL-LTS200X100

Luminaire

Product type: LED Tile Light
 Material: Stainless steel + Tempered Glass
 Dimension: H200*W100*H70mm
 IP Rating: IP67
 IK Rating: IK10
 Warranty: 3 Years

Light Source

Light source: SMD
 Lumen output: 30lm/W
 CRI: Ra>80
 CCT: 3000K/4000K/5000K/6000K
 Light emission: 120°
 Life-span: 50000Hrs

Electrical Equipment

Input voltage: DC12/24V
 Operating Temperature: -20~65°C

Accessories

Product type: Embedded box
 Material: Stainless steel
 Dimension: H205*W105XH100mm

Drawings(mm)

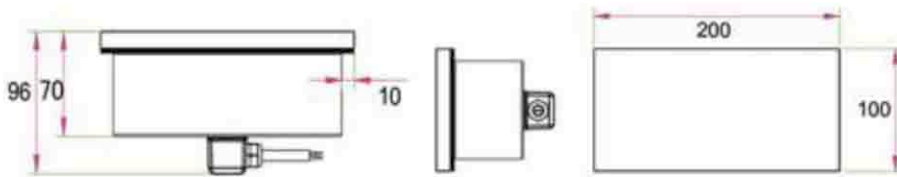

Part No.	Dimension(mm)	Power	Voltage	Color
FL-LTS200X100WD1	L200*W100*H70	2.6W	DC12V	WW/NW/CW
FL-LTS200X100SD1	L200*W100*H70	2.6W	DC12V	R/G/B/Y
FL-LTS200X100RGBD1	L200*W100*H70	2.6W	DC12V	RGB
FL-LTS200X100WD2	L200*W100*H70	2.6W	DC24V	WW/NW/CW
FL-LTS200X100SD2	L200*W100*H70	2.6W	DC24V	R/G/B/Y
FL-LTS200X100RGBD2	L200*W100*H70	2.6W	DC24V	RGB

NOTE: WW-Warm white, NW-Natural white, CW-cold white, R-red,G-green,B-Blue, Y-Yellow

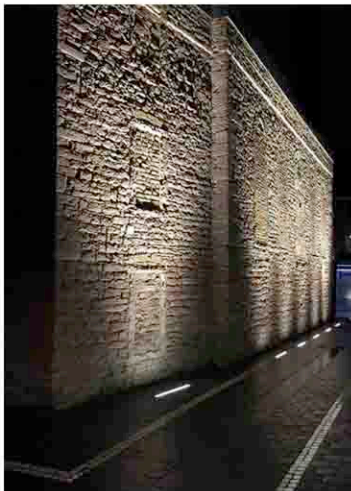

MODEL NO.
FL-LTS200X200

Luminaire

Product type: LED Tile Light
 Material:Stainless steel + Tempered Glass
 Dimension: H200 * W200 *H70mm
 IP Rating: IP67
 IK Rating: IK10
 Warranty: 3 Years

Light Source

Light source: SMD
 Lumen output: 30lm/W
 CRI: Ra>80
 CCT: 3000K/4000K/5000K/6000K
 Light emission: 120°
 Life-span: 50000Hrs

Electrical Equipment

Input voltage: DC12/24V
 Operating Temperature: -20~65°C

Accessories

Product type: Embedded box
 Material: Stainless steel
 Dimension: 205*205*100mm



Drawings(mm)

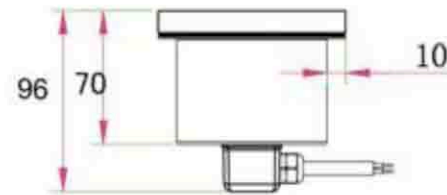
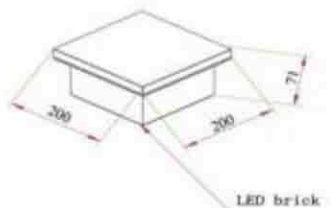

Part No.	Dimension(mm)	Power	Voltage	Color
FL-LTS200X200WD1	L200*W200*H70	4W	DC12V	WW/NW/CW
FL-LTS200X200SD1	L200*W200*H70	4W	DC12V	R/G/B/Y
FL-LTS200X200RGBD1	L200*W200*H70	4W	DC12V	RGB
FL-LTS200X200WD2	L200*W200*H70	4W	DC24V	WW/NW/CW
FL-LTS200X200SD2	L200*W200*H70	4W	DC24V	R/G/B/Y
FL-LTS200X200RGBD2	L200*W200*H70	4W	DC24V	RGB

NOTE: WW-Warm white, NW-Natural white, CW-cold white, R-red,G-green,B-Blue, Y-Yellow

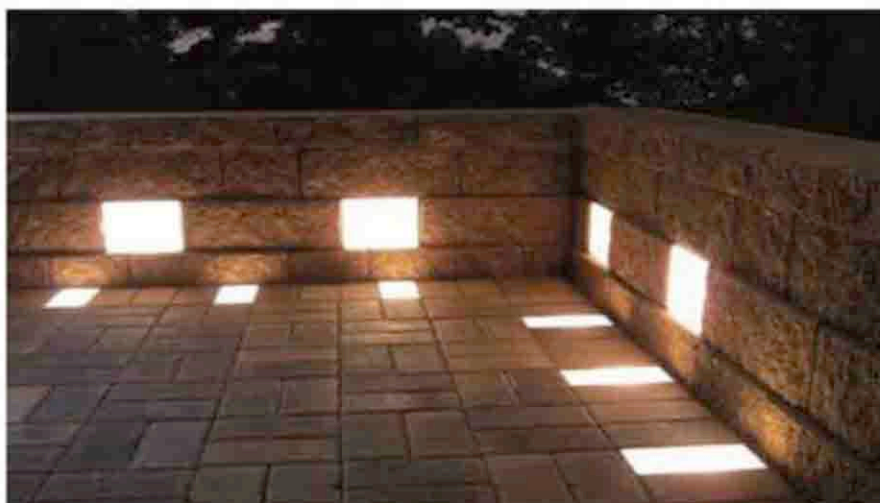



Drawings(mm)

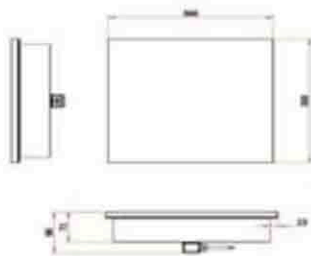
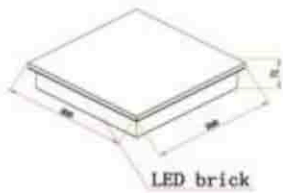

Part No.	Dimension(mm)	Power	Voltage	Color
FL-LTS300X300WD1	L300*W300*H70	7.8W	DC12V	WW/NW/CW
FL-LTS300X300SD1	L300*W300*H70	7.8W	DC12V	R/G/B/Y
FL-LTS300X300RGBD1	L300*W300*H70	7.8W	DC12V	RGB
FL-LTS300X300WD2	L300*W300*H70	7.8W	DC24V	WW/NW/CW
FL-LTS300X300SD2	L300*W300*H70	7.8W	DC24V	R/G/B/Y
FL-LTS300X300RGBD2	L300*W300*H70	7.8W	DC24V	RGB

NOTE: WW-Warm white, NW-Natural white, CW-cold white, R-red,G-green,B-Blue, Y-Yellow



MODEL NO.
FL-LTS300X300

Luminaire

Product type: LED Tile Light
Material:Stainless steel + Tempered Glass
Dimension: H300*W300*H70mm
IP Rating: IP67
IK Rating: IK10
Warranty:3 Years

Light Source

Light source: SMD
Lumen output: 30lm/W
CRI: Ra>80
CCT: 3000K/4000K/5000K/6000K
Light emission: 120°
Life-span: 50000Hrs

Electrical Equipment

Input voltage: DC12/24V
Operating Temperature: -20~65°C

Accessories

Product type: Embedded box
Material: Stainless steel
Dimension: H305*W305XH100mm

MODEL NO.
FL-LTS1000X28

Luminaire

Product type: LED Tile Light
 Material:Stainless steel + Tempered Glass
 Dimension: H1000 * W28 *H70mm
 IP Rating: IP67
 IK Rating: IK10
 Warranty: 3 Years

Light Source

Light source: SMD
 Lumen output: 30lm/W
 CRI: Ra>80
 CCT: 3000K/4000K/5000K/6000K
 Light emission: 120°
 Life-span: 50000Hrs

Electrical Equipment

Input voltage: DC12/24V
 Operating Temperature: -20~65°C

Accessories

Product type: Embedded box
 Material: Stainless steel
 Dimension: 1105*33*100mm



Drawings(mm)

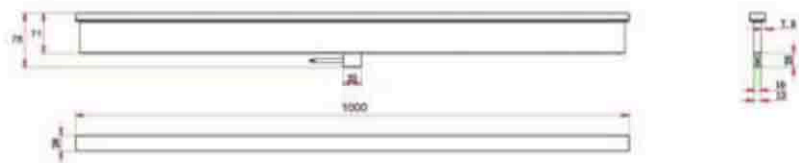

Part No.	Dimension(mm)	Power	Voltage	Color
FL-LTS1000X28WD1	L1000*W28*H70	9W	DC12V	WW/NW/CW
FL-LTS1000X28SD1	L1000*W28*H70	9W	DC12V	R/G/B/Y
FL-LTS1000X28RGBD1	L1000*W28*H70	9W	DC12V	RGB
FL-LTS1000X28WD2	L1000*W28*H70	9W	DC24V	WW/NW/CW
FL-LTS1000X28SD2	L1000*W28*H70	9W	DC24V	R/G/B/Y
FL-LTS1000X28RGBD2	L1000*W28*H70	9W	DC24V	RGB

NOTE: WW-Warm white, NW-Natural white, CW-cold white, R-red,G-green,B-Blue, Y-Yellow





MODEL NO.
FL-LTS1200X50

Luminaire

Product type: LED Tile Light
 Material: Stainless steel + Tempered Glass
 Section Dimension: H1200*W50*H70mm
 IP Rating: IP67
 IK Rating: IK10
 Warranty: 3 Years

Drawings(mm)

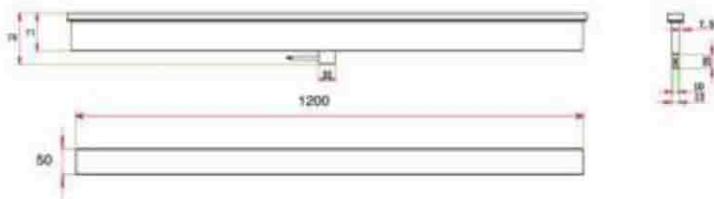

Light Source

Light source: SMD
 Lumen output: 30lm/W
 CRI: Ra>80
 CCT: 3000K/4000K/5000K/6000K
 Light emission: 120°
 Life-span: 50000Hrs

Electrical Equipment

Input voltage: DC12/24V
 Operating Temperature: -20~65°C

Accessories

Product type: Embedded box
 Material: Stainless steel
 Dimension: H1205*W55XH100mm

Part No.	Dimension(mm)	Power	Voltage	Color
FL-LTS1200X50WD1	L1200*W50*H70	15W	DC12V	WW/NW/CW
FL-LTS1200X50SD1	L1200*W50*H70	15W	DC12V	R/G/B/Y
FL-LTS1200X50RGBD1	L1200*W50*H70	15W	DC12V	RGB
FL-LTS1200X50WD2	L1200*W50*H70	15W	DC24V	WW/NW/CW
FL-LTS1200X50SD2	L1200*W50*H70	15W	DC24V	R/G/B/Y
FL-LTS1200X50RGBD2	L1200*W50*H70	15W	DC24V	RGB

NOTE: WW-Warm white, NW-Natural white, CW-cold white, R-red,G-green,B-Blue, Y-Yellow

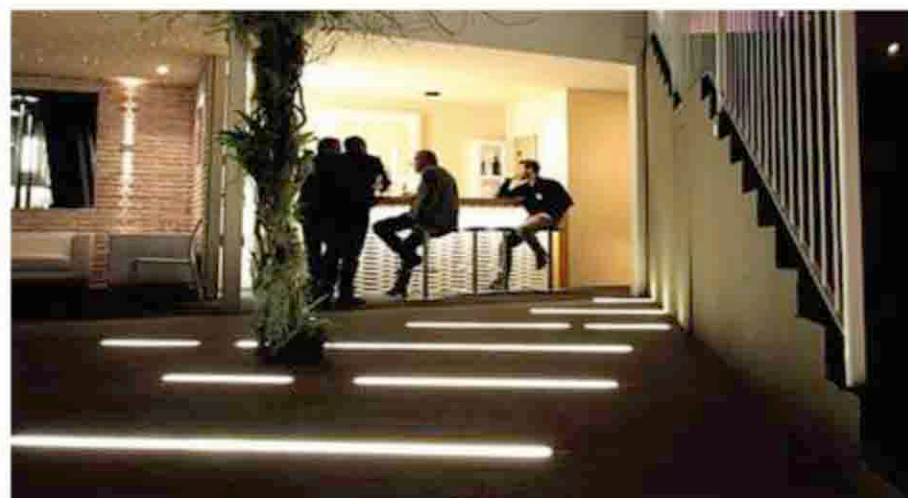

LED IN-GROUND LIGHT SERIES

CONSISTS OF ANTI-RUST AND ANTI-CORROSION STAINLESS STEEL OR ALUMINUM ALLOY BASE SHELL, AND TOUGHENED GLASS COVER WITH EXQUISITE DESIGN. WIDELY USED FOR GARDEN DECORATION, SQUARE, SIDEWALK, DRIVEWAY, HOTEL ETC

Features:

- Walk-over tempered glass.
- Anti-rust and anti-corrosion stainless steel plate
- High power led and COB are available
- Variety of beam angle for option to achieve better illumination.
- Easy to install or embedded in stone, concrete and pavers

Standards:

.IEC/EN60598-1.IEC/EN60598-2-2

.IEC/EN61000-3-2.IEC/EN61000-3-3

.IEC/EN61547.EN55015

.IEC/EN62031.ROHS





More choices of distribution type:

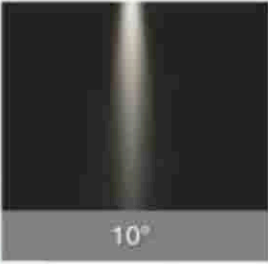

10°

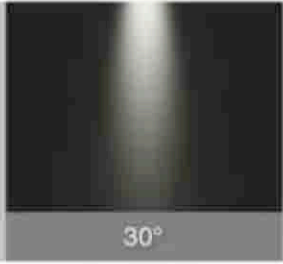

30°

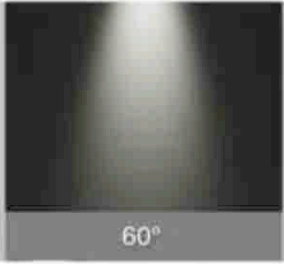

60°

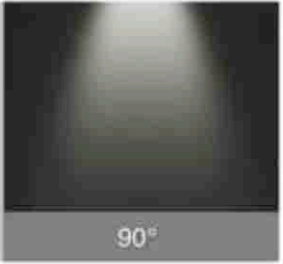

90°



120°

More wattage for option:



**More colours available:
CW/NW/WW/R/G/B/Y/RGB/RGBW**



MODEL NO.
FL-LUGL12X1

Luminaire

Product type: LED In-Ground Light
 Material: Aluminum + Tempered Glass
 Dimension: H600 * W100 *H70mm
 IP Rating: IP67
 IK Rating: IK10
 Warranty: 3 Years

Light Source

Light source: High power LED chips
 Lumen output: 90-100 lm/W
 CRI: Ra>80
 CCT: 3000K/4000K/5000K/6000K
 Light emission: 10°/15°/30°/45°/60°
 Life-span: 50000Hrs

Electrical Equipment

Input voltage: DC12/24V/AC85-265V
 Operating Temperature: -20~65°C

Accessories

Product type: Embedded box
 Material: Plastic
 Dimension: 592*86*75mm



Drawings(mm)

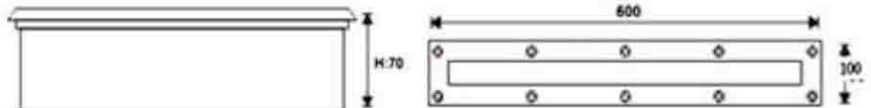

Part No.	Dimension(mm)	Power	Voltage	Color
FL-LUGL12X1WD1	L600*W100*H70	12W	DC12V	WW/NW/CW
FL-LUGL12X1SD1	L600*W100*H70	12W	DC12V	R/G/B/Y
FL-LUGL12X1RGBD1	L600*W100*H70	12W	DC12V	RGB
FL-LUGL12X1WD2	L600*W100*H70	12W	DC24V	WW/NW/CW
FL-LUGL12X1SD2	L600*W100*H70	12W	DC24V	R/G/B/Y
FL-LUGL12X1RGBD2	L600*W100*H70	12W	DC24V	RGB
FL-LUGL12X1WA4	L600*W100*H70	12W	AC85-265V	WW/NW/CW
FL-LUGL12X1SA4	L600*W100*H70	12W	AC85-265V	R/G/B/Y
FL-LUGL12X1RGA4	L600*W100*H70	12W	AC85-265V	RGB

NOTE: WW-Warm white, NW-Natural white, CW-cold white, R-red,G-green,B-Blue, Y-Yellow





MODEL NO.
FL-LUGL24X1

Luminaire

Product type: LED In-Ground Light
 Material: Aluminum + Tempered Glass
 Dimension: H1000 * W75 * H70mm
 IP Rating: IP67
 IK Rating: IK10
 Warranty: 3 Years

Drawings(mm)

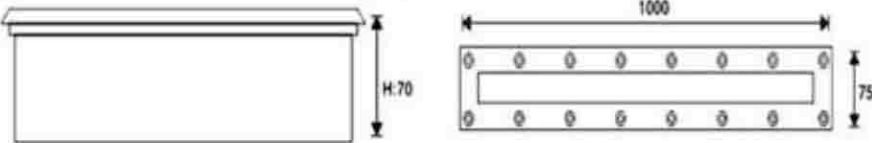

Part No.	Dimension(mm)	Power	Voltage	Color
FL-LUGL24X1WD1	L1000*W75*H70	24W	DC12V	WW/NW/CW
FL-LUGL24X1SD1	L1000*W75*H70	24W	DC12V	R/G/B/Y
FL-LUGL24X1RGBD1	L1000*W75*H70	24W	DC12V	RGB
FL-LUGL24X1WD2	L1000*W75*H70	24W	DC24V	WW/NW/CW
FL-LUGL24X1SD2	L1000*W75*H70	24W	DC24V	R/G/B/Y
FL-LUGL24X1RGBD2	L1000*W75*H70	24W	DC24V	RGB
FL-LUGL24X1WA4	L1000*W75*H70	24W	AC85-265V	WW/NW/CW
FL-LUGL24X1SA4	L1000*W75*H70	24W	AC85-265V	R/G/B/Y
FL-LUGL24X1RGA4	L1000*W75*H70	24W	AC85-265V	RGB

Light Source

Light source: High power LED chips
 Lumen output: 90-100 lm/W
 CRI: Ra>80
 CCT: 3000K/4000K/5000K/6000K
 Light emission: 10°/15°/30°/45°/60°
 Life-span: 50000Hrs

Electrical Equipment

Input voltage: DC12/24V/AC85-265V
 Operating Temperature: -20~65°C

Accessories

Product type: Embedded box
 Material: Plastic
 Dimension: 992*69*75mm

NOTE: WW-Warm white, NW-Natural white, CW-cold white, R-red,G-green,B-Blue, Y-Yellow

